

MOVE THE WORLD FORWARD  MITSUBISHI  
HEAVY  
INDUSTRIES  
GROUP

## FB-CB SERIES (1.0 - 3.5 TONS)



# ELECTRIC FORKLIFT

WHEN  
RELIABILITY IS  
EVERYTHING...

 **MITSUBISHI**  
FORKLIFT TRUCKS

# POWERING THE FUTURE OF LOGISTICS

---

The Mitsubishi FB-CB Series electric forklift is powering the way forward in logistics excellence. With load capacities of 1.0 to 3.5 tons, this new-generation electric forklift is equipped with innovative features that simplify the movement of goods. It is redefining performance, while ensuring safety, reliability and sustainability. Low operating costs and reduced maintenance requirements have also resulted in outstanding economic efficiency.



**The Mitsubishi FB-CB Series** electric forklift promises superb stability and calibrated control both within indoor confines and outdoor elements.



# SAFE AND STABLE

The FB-CB Series electric forklift boasts many safety features that place it ahead of its class. These quality applications make the forklift agile, efficient and stable, giving users flexibility and manoeuvrability.

## Low Center of Gravity

A lower center of gravity coupled with the deeper emplacement of the battery box improves traveling and turning stability.

### FB-CB Series

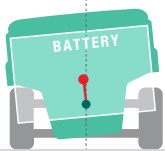

### Previous Model

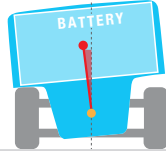

- Low center of gravity due to the battery dropping structure
- Use of high mount axle has allowed the mount position to be closer to the center of gravity

The small movement of the center of gravity during turning enables smooth and safe travelling.

## Auto Torque Up

This function is sensitive to the forklift's situation and swiftly increases the torque when required; for example, when the forklift is negotiating a slope or bearing an extra load. The auto torque up prevents the forklift from any lag brought on by a changed situation; rather, it ramps up the torque to ensure consistent performance akin to the forklift moving on flat ground.

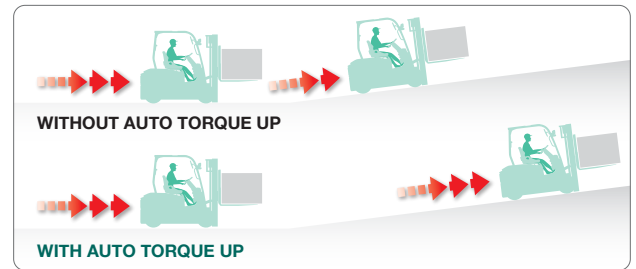

## Wide Visibility

Enhanced multi-directional visibility ensures a significantly expanded field of vision.

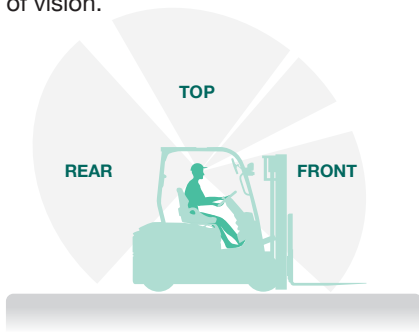

## Pitching Control

Ideal for goods protection when clearing humps.

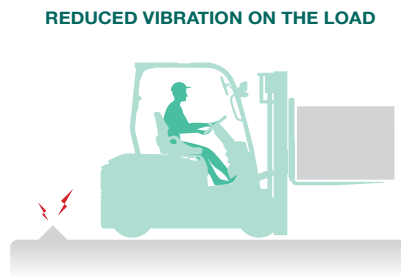

## Travel Hydraulic Interlock

This sensitive power-severance feature disengages all movement if the operator is not seated in the forklift. This intelligent feature takes forklift safety to the next level.

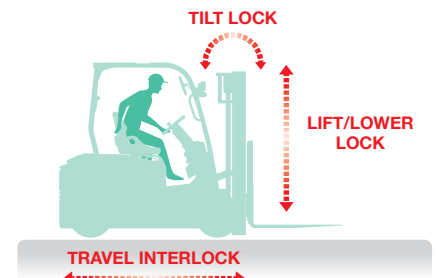

## Hydraulic Cushioning (option)

A dual-accumulator system manages pressure levels to accommodate various load capacities. This helps to absorb shocks and prevent damage to goods when travelling over varying terrains.

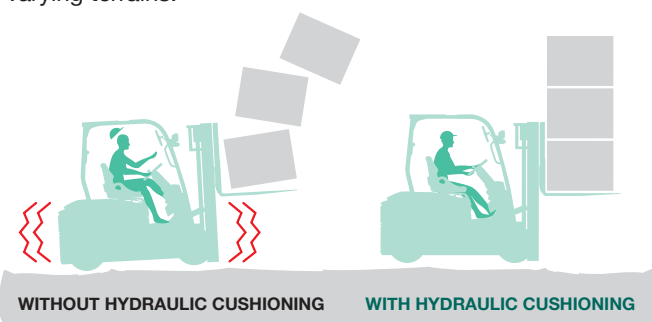

## Safety Cruise

This feature prevents any sudden slide even when the accelerator and brake pedals are released, limiting speed to 1km/h (controlled roll back). Speed suppression also kicks in when the forklift is downslope.

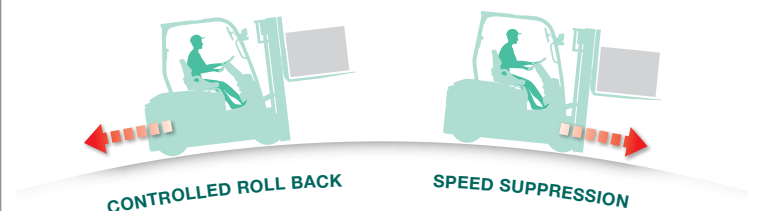



### Rear LED Line & Blue Spot Light (option)

The Rear LED Line is a unique feature of the forklift that safeguards pedestrians. With the Blue Spot Light that illuminates the floor, both these features improve safe operations, especially within confined internal spaces.



### Load Indicator and Overload Warning (option)

The load indicator displays the weight of goods being lifted. A visual warning will alert the operator if the load exceeds the maximum weight capacity.



The weight value that appears on the load indicator should be read as a reference and not as the actual load weight.

### Travel, Speed, Lift, and Tilt Control Features

- **Speed limiter:** A critical travel safety device that controls and limits speed.
- **Speed reduction when turning:** Curve control automatically reduces speed when turning.
- **Travel speed limit by load weight (option):** Limits speed when the load exceeds specified load capacity.
- **Travel speed limit by lift height (option):** Limits speed based on the lift height of the load.
- **Tilt speed limit at high lift (option):** Limits tilt speed based on the height of the load lift.

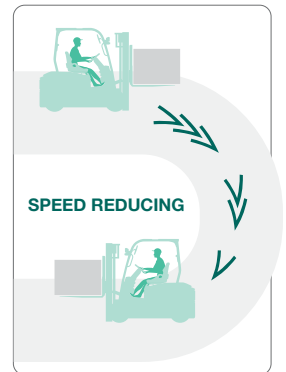

### Other Safety Additions

- **Orange seatbelt (option):** Better visibility facilitates effective monitoring of seat belt use by safety managers and encourages accountability and proper safety implementation.
- **Password Entry (option):** The forklift operation is password protected, a crucial security feature.
- **Emergency stop button** that is free from any dashboard obstructions
- **Audible/visual parking brake warning:** Both audible and visual warnings alert the operator should he leave the seat or forklift without engaging the parking brake.





15

MITSUBISHI

# SURE AND STEADFAST

Reliability and sustainability are key attributes of the forklift's power. The integrity of the forklift's build quality is assured; and its performance, steadfast.



## Energy Efficient

- **ECO Mode Button:**

The ECO Mode optimizes forklift performance — including speed and power of execution — while saving energy at the same time for future use.

- **Regeneration:**

Multiple regenerative functions enable the forklift to recover energy wastage.

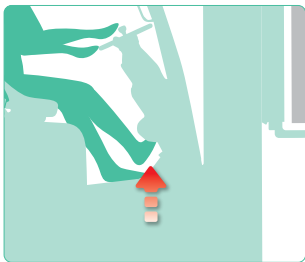

### Coasting

Recovery when the foot is lifted off the accelerator.

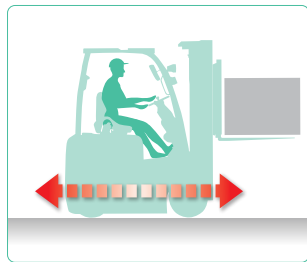

### Plugging

Recovers when the direction changes.

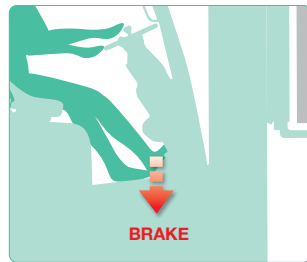

### Braking

Recovers when the footbrake is engaged.

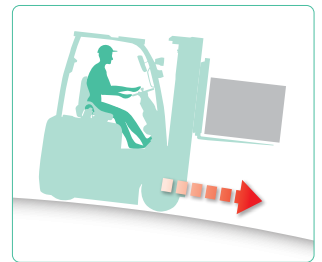

### Speed suppression on Downslopes

Recovery when coasting downslope.

## AC Motor

A high-output, maintenance-free AC motor delivers smooth driving, superb control, and powerful lifting. Ensuring consistently strong performance, the AC motor achieves faster acceleration and swifter responsiveness.



## Battery Protection

At low battery levels, restricted lift ability and limited travel speed instinctively signal the need for re-charging.

### Waterproof Class IPX4

This higher level waterproof class is most resistant to external environments. Its anti-splash quality protects the forklift against water sprays from all directions.



# CONTROL AND COMFORT

Effective control combines with excellent ergonomics to make the FB-CB Series electric forklift a formidable machine that is also equipped with high levels of ease and comfort.



## Customizable Operation Characteristics

This unique feature pushes the boundaries in forklift technology. The forklift is built with operational characteristics that can be customized to suit an operator's level of experience and skill, style of operation, and functional preferences. Customizable aspects include both traction and hydraulics.

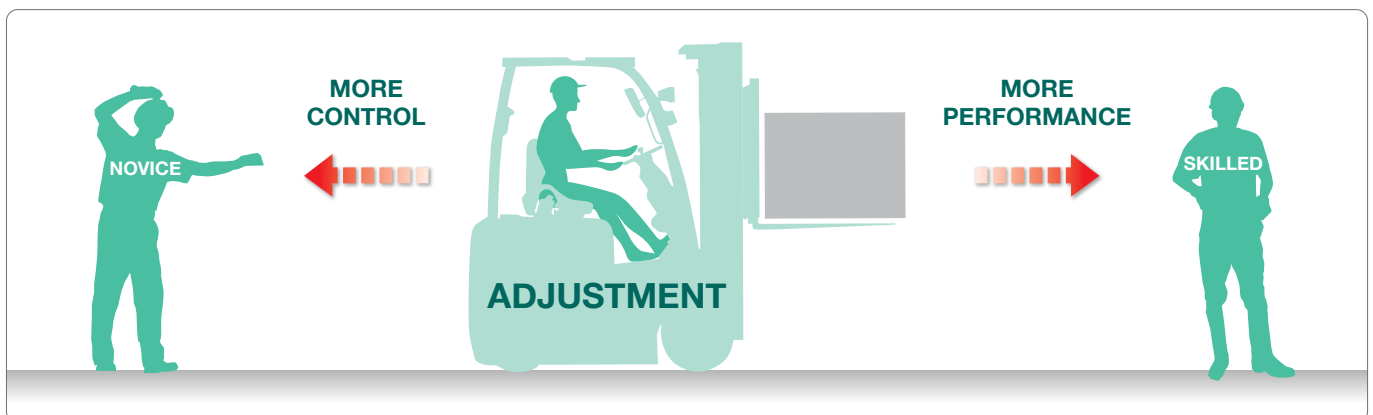



### Fingertip Control (option)

Clearly within reach at the arm rest, fingertip control buttons facilitate ease of operations.



### Dashboard Display

A low-profile dashboard display is clear of obstruction, and relays updated information in interactive mode.



### Easy Battery Exchange (option)

The side-loading battery compartment is conveniently accessible, and exchanges are easy and quick.

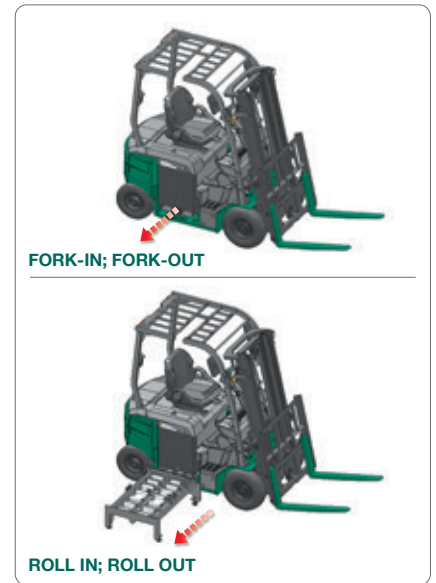

### Rear Hand Grip with Horn

This grip is held when reversing with a horn for added safety to warn pedestrians.



### Ease of Entry and Exit

Good ergonomics includes a low step height, a wide operator compartment, luxurious head room, and a narrow steering column cover.



### LED Lights (option)

LED lights are available for the head lamp and rear combination lamp. Options include rotating lights or flash lamps. These high-intensity lights are energy saving, durable, cooler and sturdier.



### Optional Features and Parts

- **Laser Pointer:** Allows operators to see fork entry points at high levels.
- **Tilt horizontal leveling:** Automatically stops the forks at a horizontal position.
- **Front wind shield/ acrylic roof/ rear windshield:** Shielding from wind and rain.
- **Attachment:** A wide range of attachment is available for every application. These include side shifter, fork adjusters, rotating forks and clamps.
- **Cold store:** Critical protection from extreme cold (up to  $-55^{\circ}\text{C}$ ) when operating in cold rooms. Most importantly, the components are completely protected from the ravages of condensation that could potentially lead to stalling. All essential fluids used contain effective anti-freeze solutions.

# SPECIFICATIONS

Type	Item		Unit	FB10CB	FB15CB	FB18CB	FB20CB	FB25CB	FB20LCB	FB25LCB	
	Standard type							Long wheelbase type			
Capacity	Capacity at rated load center		kg	1,000	1,500	1,750	2,000	2,500	2,000	2,500	
	Load center – distance		mm	500	500	500	500	500	500	500	
Dimensions	Height to top of overhead guard		h6	mm	2110	2110	2110	2110	2110	2110	
	Height with mast lowered		h1		1990	1990	1990	1995	1995	1995	1995
	Lift height		h3		3000	3000	3000	3000	3000	3000	3000
	Overall height with mast raised		h4		4055	4055	4055	4055	4055	4055	4055
	Free lift		h2		115	115	115	140	140	140	140
	Tilt	Forward	α		°	7	7	7	7	7	7
		Backward	β	°	11	11	11	11	11	11	11
	Ground clearance	Under Mast	m1	mm	110	110	110	115	115	115	115
		Center of wheelbase	m2		110	110	110	110	110	110	110
	Front overhang		F		395	395	395	445	445	445	445
	Rear overhang		C		275	275	315	340	380	340	340
	Overall length		L1		3150	3150	3190	3375	3415	3535	3535
	Length to fork face (includes fork thickness)		L2		2080	2080	2120	2305	2345	2465	2465
	Wheelbase		L3		1410	1410	1410	1520	1520	1680	1680
	Minimum outside turning radius		R		1850	1850	1880	2030	2080	2215	2215
Thread	Front	Single Tire	B5		930	930	925	955	955	955	955
	Rear		B6		900	900	900	965	965	965	965
Overall width		Single	B		1100	1100	1115	1155	1155	1155	1155
Fork spread – out-to-out	Maximum	B3	920		920	920	995	995	995	995	
	Minimum	B4	240		240	240	260	260	260	260	
Forks	Width	W	100		100	100	122	122	122	122	
	Thickness	t	35		35	35	40	40	40	40	
	Length	L	1070	1070	1070	1070	1070	1070	1070		
Performance	Travel speed	Laden	Pneumatic	km/h	14.0	14.0	13.5	14.0	14.0	14.0	
		Unladen	Pneumatic		16.0	16.0	15.5	16.0	16.0	16.0	
	Lift speed	Laden		mm/s	390	350	330	290	260	290	
		Unladen			540	540	540	470	470	470	
	Maximum gradeability - laden (3 min. rating, 1.5km/h and over)			%	22	19	17	19	16	18	16
Maximum gradeability - unladen (3 min. rating, 1.5km/h and over)			%	25.0	25.0	24.0	22.5	20.0	20.5	20.5	
Mass	Service Weight without battery			kg	2060	2190	2420	2895	3270	2965	2965
	Battery Weight	Minimum		kg	570	600	600	715	810	1025	1025
		Maximum		kg	875	910	910	1025	1025	1360	1360
Chassis	Tire size	Front	Pneumatic Single		6.00-9 10PR		21x8-9 14PR	21x8-9 16PR			
		Rear	Pneumatic		5.00-8 8PR			18x7-8 14PR			
	Miscellaneous	Steering type			Full Hydraulic Power Steering						
		Service brakes			Hydraulic						
Parking brakes			Mechanical Hand-operated								
Electrical	Motor	Drive motor (60 min. rating)		kW	7.0	7.0	7.0	8.5	8.5	8.5	8.5
		Lift motor (10 min. rating)			9.5	9.5	9.5	11.5	11.5	11.5	11.5
		Steering motor (60 min. rating)			1.5	1.5	1.5	1.5	1.5	1.5	1.5
	Drive / Hydraulic / Steering controls				AC Inverter						
Battery		STD		V/Ah(5HR)	48/370	48/415	48/415	48/510	48/565	48/725	48/725
Charger (3 phase 400/200V)	Type				Automatic Stationary Charger						
	STD			kVA	6.5	6.5	6.5	8.1	8.1	11.0	11.0

These specifications are subject to change without notice to improve performance.

FB30CB	FB35CB
Standard type	
3,000	3,500
500	500
2200	2200
2015	2115
3000	3000
4055	4055
140	145
7	7
11	11
135	135
120	120
485	490
340	430
3575	3670
2505	2600
1680	1680
2260	2330
1030	1030
980	980
1255	1255
995	995
280	280
122	122
45	50
1070	1070
13.5	13.5
15.5	15.5
320	270
550	460
16	13
20	19.5
3790	4340
1095	1095
1540	1540
28×9-15 14PR	
6.50-10 10PR	6.50-10 12PR
11.0	11.0
15.0	15.0
1.7	1.7
72/470	72/470
12.0	12.0

## FB-CB Series

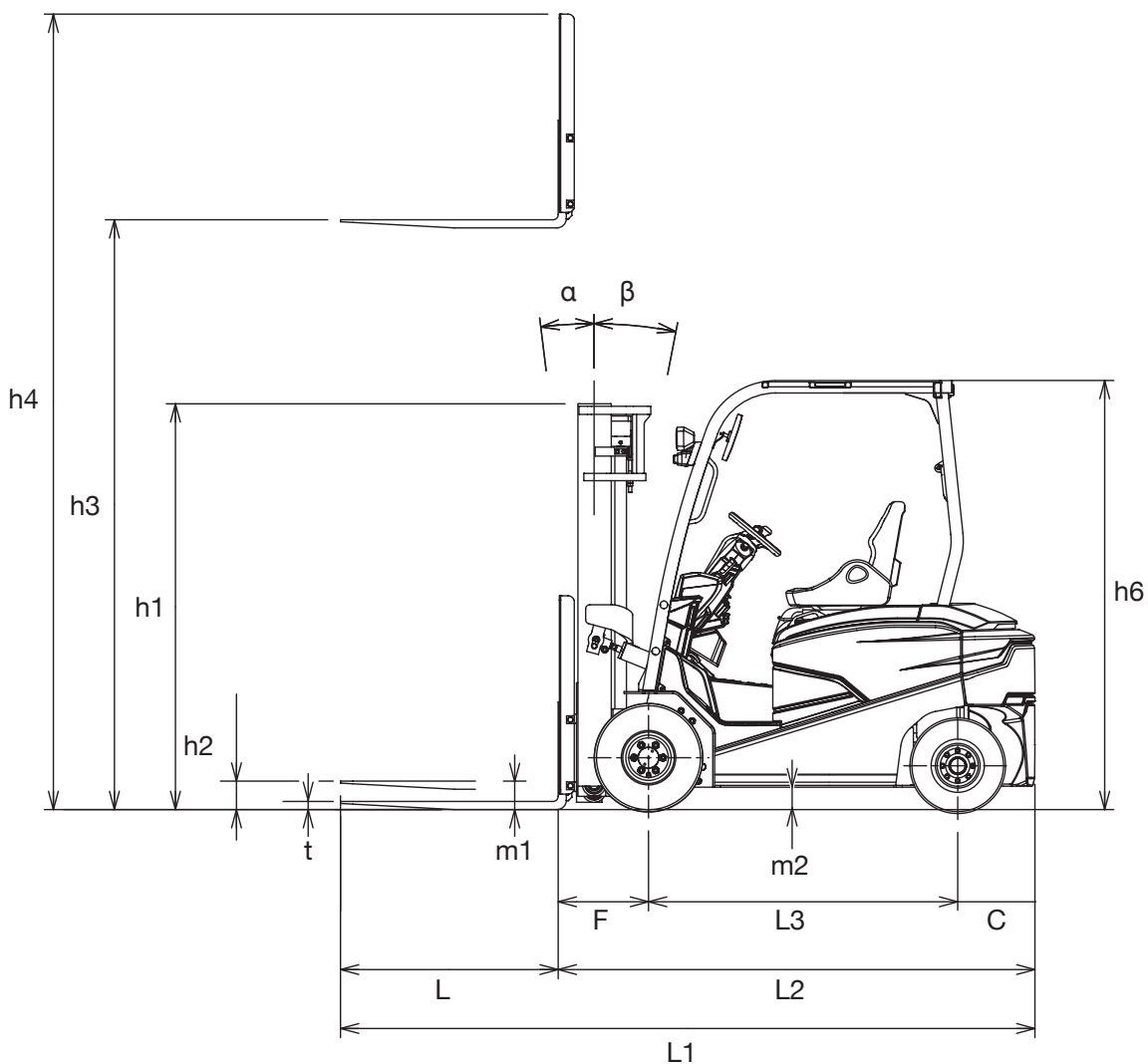
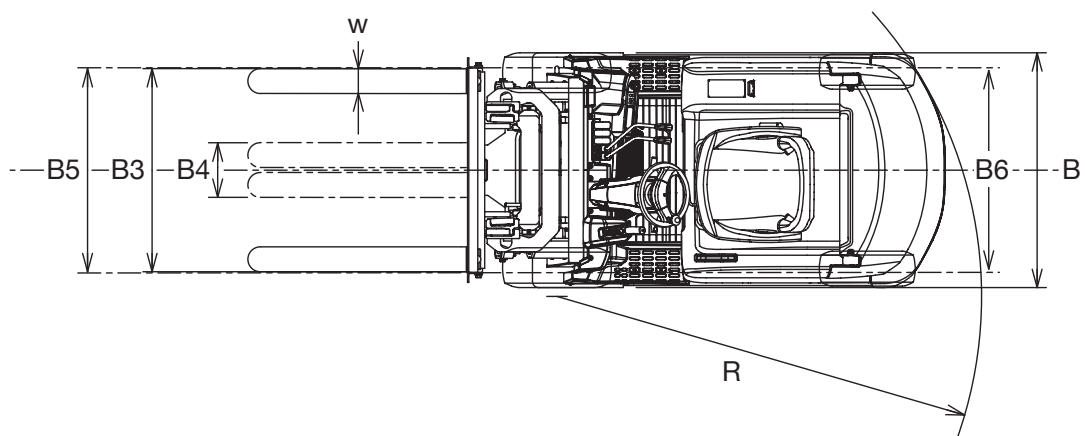

**Like any product bearing the "MITSUBISHI" name our materials handling equipment benefits from the tremendous heritage, huge resources and cutting-edge technology of one of the world's largest corporations – Mitsubishi Heavy Industries Group.**

Engineering spacecraft, jet planes, power plants and more, MHI specialises in those technologies where performance, dependability and superiority decide your success or failure...

So when we promise you quality, reliability and value for money, you know it's a guarantee we have the power to deliver.

That's why every model in our award-winning and comprehensive range of lift trucks and warehouse equipment is built to a high specification – to ensure it keeps working for you. Day after day. Year after year. Whatever the job. Whatever the conditions.

## **YOU'LL NEVER WORK ALONE**

As your local authorised dealer, we are here to keep your trucks working – through our extensive experience, our technical excellence and our commitment to customer care.

We are your local experts, backed by efficient channels to the entire organisation of Mitsubishi Forklift Trucks.

No matter where you are, we are close by – with the capability to meet your needs.

Discover how Mitsubishi Forklift Trucks give you more from your local authorised dealer or when you visit our website [www.mitforklift.com.sg](http://www.mitforklift.com.sg)

Performance specifications may vary depending on standard manufacturing tolerances, vehicle condition, types of tyres, floor or surface conditions, applications or operating environment. Trucks may be shown with non-standard options. Specific performance requirements and locally available configurations should be discussed with your distributor of Mitsubishi forklift trucks. We follow a policy of continual product improvement. For this reason, some materials, options and specifications could change without notice.

© 2020 by MLAP. All Rights Reserved. All registered trademarks are the property of their respective owners. Printed in Singapore.

FMIT0175 (08/20)

